

IMPORTANT NOTES

Towers should only be erected by competent trained personnel and records of both erection and regular inspection every seven days maintained.

At working platform levels fit a standard and hatchdoor platform on (D/Width) and hatchdoor (on S/Width), with the hatchdoor over the ladderframes and the hinges on the outside. Also fit guardrail frames, double handrails and toeboards.

Regulations state that any intermediate or rest platform from which there is a risk of falls must have double handrails and if used as a working platform, a toeboard. This applies even to low level platforms under 2M.

Under new legislation a rest platform is required on towers erected to a height of 6.03 M (19'9") or more. However current British Standards that additional rest or intermediate platforms are required initially at 4.5 M above the ground and every 4.0 M thereafter. Guardrails should be fitted to every rest platform where installed plus a toeboard (if used as a working platform)

In such cases consult your supplier for verification of additional equipment required other than that shown overleaf.

Stabilisers can be fitted at lower heights than shown in the component breakdown to increase tower stability.

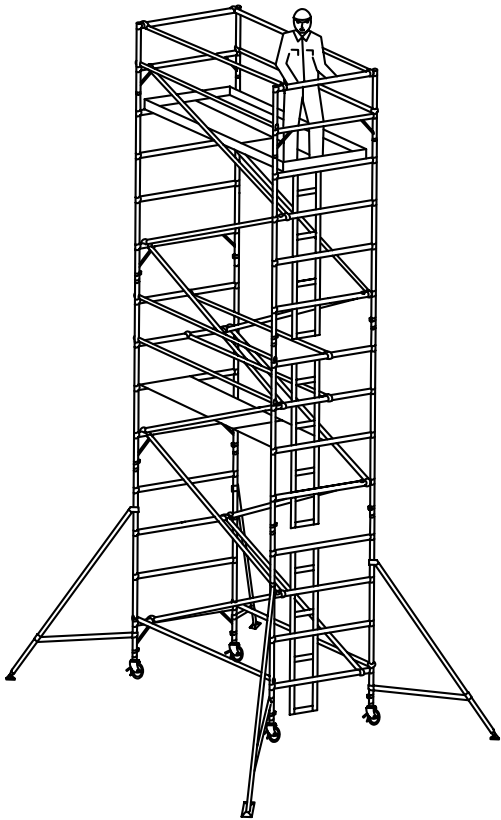

TYPICAL D/W TOWER
(REST PLATFORM SHOWN)

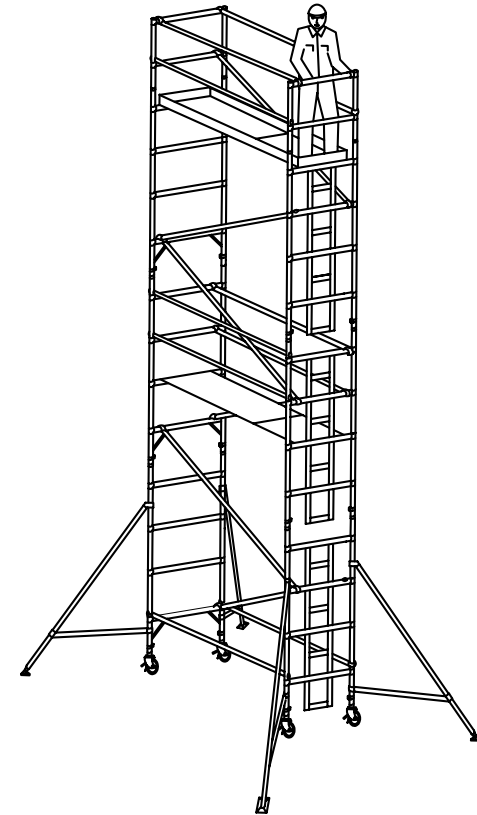

TYPICAL S/W TOWER
(REST PLATFORM SHOWN)

SIDES
CLEAT SLOTS POINT DOWN

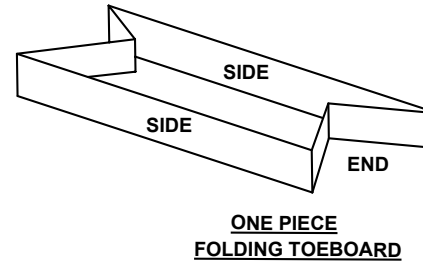
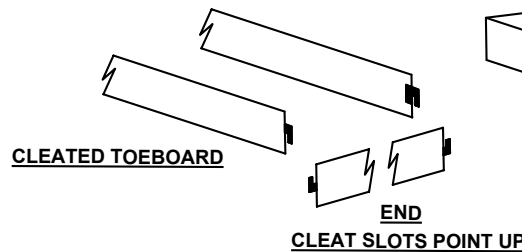

STATIC STABILISERS

STABILISER	MAX PLAT HT	
	I/DOOR	O/DOOR
TOWER	8.2 M	8.2 M
S/WIDTH	8.2 M	8.2 M
D/WIDTH	9.2 M	9.2 M

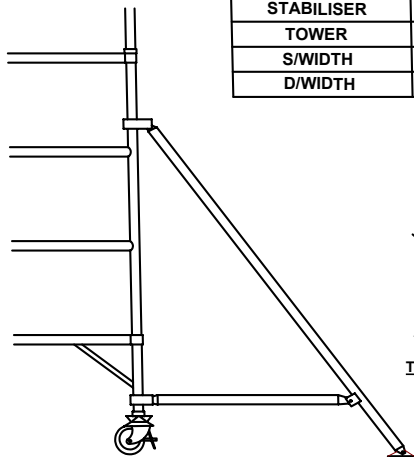

STATIC STABILISER

FOR FREE STANDING TOWERS EXCEEDING THE RECOMMENDED HEIGHTS CONSULT YOUR SUPPLIER

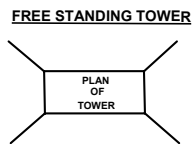

THIS ILLUSTRATION SHOWS OPTIMUM POSITIONS FOR STABILISERS AND OUTRIGGERS

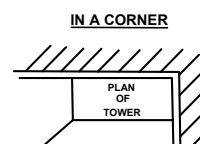
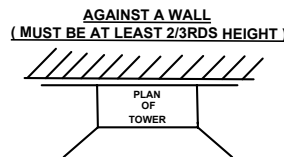

SAFE WORKING LOADS

6 FT PLATFORMS 275 Kg (605 lb each)

8 FT PLATFORMS 250 Kg (550lb each)

10 FT PLATFORMS 225 Kg (495lb each)

THE SAFE WORKING LOAD ON A DOUBLE WIDTH FULLY DECKED PLATFORM IS 275 Kg (EVENLY DISTRIBUTED)

FOR SINGLE WIDTH TOWERS FOLLOW SAFE WORKING LOADS OF INDIVIDUAL PLATFORMS ABOVE Castors 225 Kg (EACH)

TOWER 750 Kg (MINUS SELF WEIGHT OF THE TOWER)

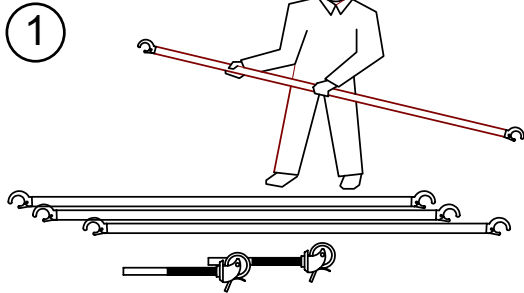

Before erecting the tower ensure site conditions are safe, especially regarding ground and wind conditions. Operatives must be competent and familiarize themselves with this assembly manual. Also make sure sufficient equipment is available to erect required height tower and that components are not damaged or incompatible. Check the component breakdown overleaf for quantities of components required.

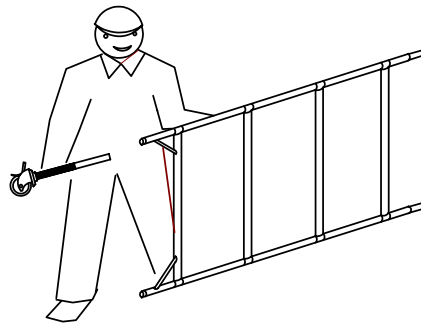

Insert castors (or base plates) into adjustable legs and then into two frames which are to be used as base frames, one of the base frames must have the in-built ladder.

2

To prime hook

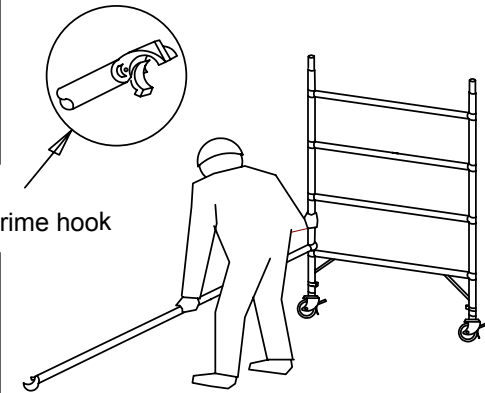

3

Begin erecting by clipping two horizontal braces as shown (hooks facing outwards) to the vertical of the frame.

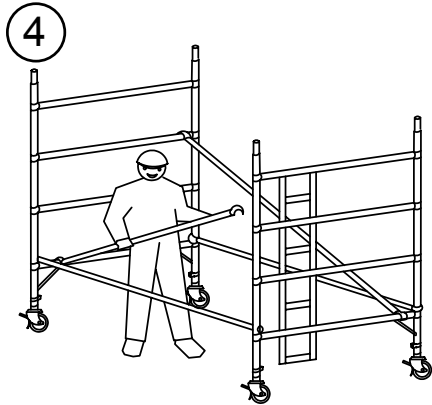

4

Clip the other end of horizontal braces to opposite frame fit two diagonals from first to third rung as shown, level tower and lock all castors. Use adjustable legs to level tower. **Do not use adjustable legs for extra height, they are for levelling only.** Make sure the offset ladder in the frame will be oriented correctly for the trapdoor platform to open outwards.

DO NOT, UNDER ANY CIRCUMSTANCES ATTEMPT TO EXTEND ALL THE ADJUSTABLE LEGS ON THE TOWER TO GAIN EXTRA HEIGHT. DO NOT ATTEMPT TO MOVE A TOWER WITH ANY LEG WHICH HAS BEEN EXTENDED BY MORE THAN 100 mm.

IF UNSURE CONSULT YOUR SUPPLIER

We advise that at least two persons should erect towers for safety reasons

Self retaining clip

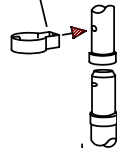

5

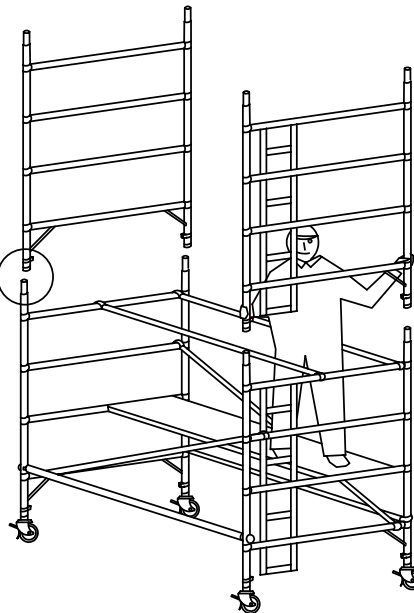

Using a temporary platform and horizontal braces as a guardrail to assist, fit upper frames ensuring the ladder is directly above the one below. If going above 4.03 M (Double Width) or 2.03 M (Single Width) fit the appropriate stabilisers now. Ropes may be used to assist in the erection and dismantling, if so tie components securely. Ensure that the hinged side of the trapdoor platform is on the outside of the tower and not in the centre.

6

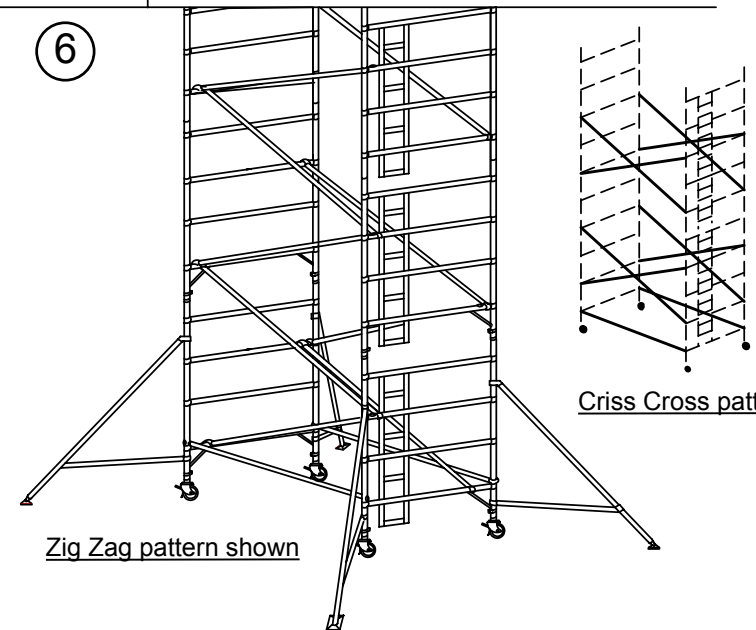

Zig Zag pattern shown

Criss Cross pattern

Using temporary platforms and guardrail brace to assist fit diagonal braces as shown these will overlap from one frame to another when using the zig-zag bracing pattern on one side and a reverse zig zag on the other. For Single Width towers use 2 diagonals per 2M lift. Move the temporary platform and horizontal braces up the tower as you build it. Bracing patterns may vary to suit on site conditions and either a zig-zag or criss cross pattern or a combination of both would be acceptable.

IF IN DOUBT DO NOT GUESS ASK YOUR SUPPLIER

STAIRSPAN TOWERS

BEFORE ERECTING TOWER

SAFETY NOTES

- 1) Ensure that the instruction guide has been read and understood by anyone using the equipment. If in doubt contact your supplier. Towers should only be erected by a competent person.
- 2) All components should be checked for damage. Do not use damaged or incompatible equipment. Make sure you have the correct amount. Quantities and types of components are listed in the Tower Breakdown.
- 3) Check ground conditions before erecting tower. It should be firm and free from obstructions.
- 4) Be careful not to infringe local bylaws when erecting towers in public places and that warning signs are fitted if required by law.
- 5) Never erect a tower where it might come into contact with unprotected cables, unguarded machinery, acids or similar corrosive substances which could be harmful to aluminium.

WHILST ERECTING TOWER

- 1) Check that you have all the components as regards quantities and types listed in the tower breakdown in this leaflet for the height of tower you are erecting.
- 2) If the height of the tower is greater than that shown on the breakdown, consult your supplier as to how towers should be tied into a building or rigid structure.
- 3) Ground conditions must be taken into account. On soft ground a suitable base must be provided (e.g. scaffold boards)
- 4) Make sure the tower is level and vertical.
- 5) Stabilisers must be fitted where specified and be fitted and used correctly.
- 6) Use a temporary platform and horizontal braces to work from as you erect or dismantle the tower.
- 7) The safe working load of platforms in this tower depends on the platform length and is shown overleaf. All loads must be evenly distributed. The maximum safe working load of the tower deck area for a double width tower is 275 Kg. For single width towers do not exceed the safe working load of the individual platforms shown overleaf.
- 8) The Working at Height Regulations state that guardrail heights should be a minimum of 950 mm and an intermediate guardrail must be fitted so that there is a gap no larger than 470mm on any working or access platform. All working platforms (including low level ones) must be fitted with guardrails and toeboards. An assessment of the risk of falls and the appropriateness of equipment to be used should be conducted prior to the erection of the tower.

WHILST USING THE TOWER

- 1) Do not exceed the safe working load of the tower (750Kg including the self weight of the tower)
- 2) Make sure a safe means of access is available and in place. Always climb up the inside of the tower.
- 3) Make sure the castors are locked, and the tower is both level and vertical.
- 4) Beware of high wind conditions. Cease working on a tower if winds exceed 7.7 metres per second (17mph). Tie the tower to a rigid structure where winds exceed 11.3 m/sec (25mph). If the wind is likely to reach gale force, over 18 m/sec (40mph) the tower should be dismantled. If unsure about the wind conditions consult your supplier.
- 5) If tower is left unattended it must be secured against unauthorised usage or adverse wind conditions.
- 6) Do not lean ladders up against the tower. Use only recommended ladder access. Never allow ladders to rest on floor.
- 7) Do not under any circumstances extend the adjustable legs to gain extra height. These are for levelling the tower only.
- 8) Do not use steps ladders or boxes, etc. to gain additional height.
- 9) For linked towers or special applications, do not take chances. Consult your supplier.
- 10) Limit the horizontal force on the tower to 20Kg (44lb) on free standing tower (eg power tools).
- 11) If the tower is moved, the following procedure must be observed:-

Before moving

- a) Make sure the tower is within recommended height to base ratios for moving (ie no greater than 2.5 times the smallest base dimension or 4m overall height. Dismantle to correct height if necessary.
- b) Do not under any circumstances attempt to move the tower with any leg extended by more than 100mm.
- c) When moving the tower, do not remove the stabilisers which should continue to be deployed at all times with the feet raised 25 mm to clear ground obstructions.
- d) Never move tower with men or materials on the platform area. Remove ties if fitted.
- e) Beware of overhead hazards and make sure the route to be taken is level and free from holes and other obstructions
- f) Push manually at base only.
- g) Caution should be exercised when wheeling a tower over rough, uneven or sloping ground, taking care to unlock and lock castors.

After moving tower

- a) Re-lock castors and check vertical and horizontal alignment.
 - b) Re-position stabilisers correctly and make sure they have a sound footing.
 - c) If necessary, re-tie tower to a rigid structure.
- 12) Do not suspend mobile access towers without referring to your supplier.
 - 13) A tower must be kept in good working order, therefore, a competent person should inspect the tower at least once a week to check for damage to the components and that the tower has not been altered in any way. Any parts found to be faulty or missing should be replaced. Welds should be inspected and any item with broken welds should be put aside for repair by the manufacturer. If in doubt consult your supplier. Clean and lightly lubricate adjustable legs to keep them free running.

WHEN DISMANTLING TOWER

- 1) Keep to the instructions in this guide. Use a temporary platform and guard rails to work from whilst dismantling.
- 2) Never throw equipment from the tower, always lower the equipment down to ground level by rope or hand.
- 3) Always report damaged equipment as components should be maintained in a serviceable condition.

IF IN DOUBT ABOUT ANY APPLICATION CONSULT YOUR SUPPLIER FOR ADVICE

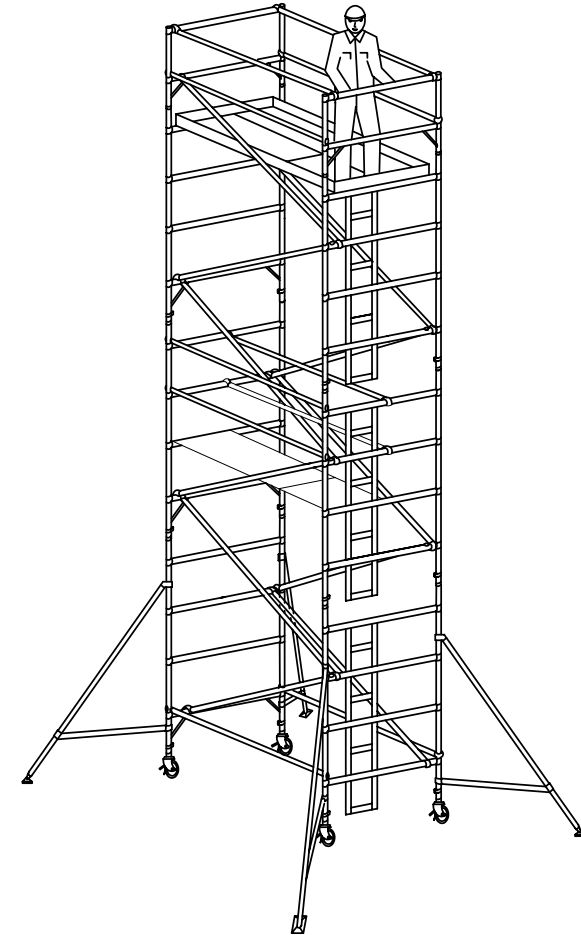

ASSEMBLY INSTRUCTIONS

STAIRSPAN TOWERS

TOWER BREAKDOWN FOR DOUBLE WIDTH TOWERS

PLAT. HGHT.		ADJ LEG	CAS-TOR	2M FRM	1.5M FRM	1M FRM	2M LADD FRM	1.5M LADD FRM	1M LADD FRM	G/R FRM	DIA BRC	G/R BRC	STD PLAT	H/D PLAT	D/W T/BD	STAB	TOWER WEIGHTS (KG)		
M	Ft.																6' (1.8 M)	8' (2.4 M)	10' (3.0 M)
1.03	3'5"	4	4	-	-	1	-	-	1	2	2	6	2	-	1	-	79	84	87
1.53	5'0"	4	4	-	1	-	-	1	-	2	3	6	1	1	1	-	84	109	114
2.03	6'8"	4	4	1	-	-	1	-	-	2	4	6	1	1	1	-	104	129	136
2.53	8'4"	4	4	-	1	1	-	1	1	2	5	6	1	1	1	-	118	139	149
3.03	9'11"	4	4	1	-	1	1	-	1	2	6	6	1	1	1	-	122	147	157
3.53	11'7"	4	4	1	1	-	1	1	-	2	7	6	1	1	1	-	131	152	167
4.03	13'3"	4	4	2	-	-	2	-	-	2	8	6	1	1	1	-	134	160	170
4.53	14'10"	4	4	1	1	1	1	1	1	2	9	6	1	1	1	4	180	210	220
5.03	16'6"	4	4	2	-	1	2	-	1	2	10	6	1	1	1	4	191	227	237
5.53	18'2"	4	4	2	1	-	2	1	-	2	11	6	1	1	1	4	200	233	248
6.03	19'9"	4	4	3	-	-	3	-	-	2	12	10	1	2	1	4	202	239	250
6.53	21'5"	4	4	2	1	1	2	1	1	2	13	10	1	2	1	4	212	248	256
7.03	23'0"	4	4	3	-	1	3	-	1	2	14	10	1	2	1	4	220	248	256
7.53	24'8"	4	4	3	1	-	3	1	-	2	15	10	1	2	1	4	222	267	279
8.03	26'3"	4	4	4	-	-	4	-	-	2	16	10	1	2	1	4	232	278	290
8.53	28'0"	4	4	3	1	1	3	1	1	2	17	10	1	2	1	4	252	291	301
9.03	29'6"	4	4	4	-	1	4	-	1	2	18	14	1	3	1	4	271	305	318
9.53	31'3"	4	4	4	1	-	4	1	-	2	19	14	1	3	1	4	280	317	330

THE DIAGONAL BRACES ON THE 1.03 M TOWER ARE A SPECIAL SIZE
CONSULT YOUR SUPPLIER FOR AVAILABILITY.

TOWER BREAKDOWN FOR SINGLE WIDTH TOWERS

PLAT. HGHT.		ADJ LEG	CAS-TOR	2M FRM	1.5M FRM	1M FRM	2M LADD FRM	1.5M LADD FRM	1M LADD FRM	G/R FRM	DIA BRC	G/R BRC	H/D PLAT	S/W T/BD	STAB	TOWER WEIGHTS (KG)		
M	Ft.															6' (1.8 M)	8' (2.4 M)	10' (3.0 M)
1.03	3'5"	4	4	-	-	1	-	-	1	2	2	6	1	1	-	62	74	78
1.53	5'0"	4	4	-	1	-	-	1	-	2	2	6	1	1	-	73	91	95
2.03	6'8"	4	4	1	-	-	1	-	-	2	2	6	1	1	-	93	106	112
2.53	8'4"	4	4	-	1	1	-	1	1	2	3	6	1	1	4	100	113	119
3.03	9'11"	4	4	1	-	1	1	-	1	2	3	6	1	1	4	107	121	128
3.53	11'7"	4	4	1	1	-	1	1	-	2	3	6	1	1	4	112	126	130
4.03	13'3"	4	4	2	-	-	2	-	-	2	4	6	1	1	4	115	130	136
4.53	14'10"	4	4	1	1	1	1	1	1	2	4	6	1	1	4	140	170	178
5.03	16'6"	4	4	2	-	1	2	-	1	2	5	6	1	1	4	144	177	184
5.53	18'2"	4	4	2	1	-	2	1	-	2	5	6	1	1	4	146	182	193
6.03	19'9"	4	4	3	-	-	3	-	-	2	6	10	2	1	4	168	191	210
6.53	21'5"	4	4	2	1	1	2	1	1	2	6	10	2	1	4	173	199	212
7.03	23'0"	4	4	3	-	1	3	-	1	2	7	10	2	1	4	182	206	183
7.53	24'8"	4	4	3	1	-	3	1	-	2	7	10	2	1	4	187	210	222
8.03	26'3"	4	4	4	-	-	4	-	-	2	8	10	2	1	4	190	214	225
8.53	28'0"	4	4	3	1	1	3	1	1	2	8	10	2	1	4	202	214	237
9.03	29'6"	4	4	4	-	1	4	-	1	2	9	14	3	1	4	223	241	242
9.53	31'3"	4	4	4	1	-	4	1	-	2	9	14	3	1	4	237	259	274

THE DIAGONAL BRACES ON THE 1.03 M TOWER ARE A SPECIAL SIZE
CONSULT YOUR SUPPLIER FOR AVAILABILITY.

TOWER COMPONENT GUIDE

DOUBLE WIDTH FRAMES

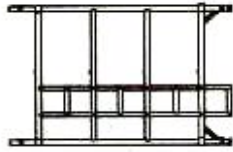

2.0M D/WIDTH LADDERFRAME



1.5M D/WIDTH LADDERFRAME

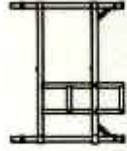

1.0M D/WIDTH LADDERFRAME



D/WIDTH GIR/RAIL FRAME

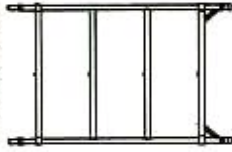

2.0M D/WIDTH FRAME

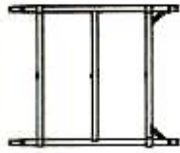

1.5M D/WIDTH FRAME



1.0M D/WIDTH FRAME

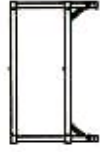

D/WIDTH GIR/RAIL FRAME

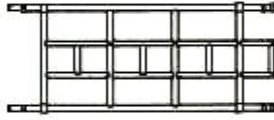

2.0M S/WIDTH LADDERFRAME

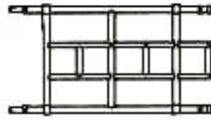

1.5M S/WIDTH LADDERFRAME

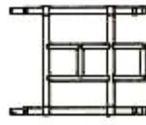

1.0M S/WIDTH LADDERFRAME



S/WIDTH GIR/RAIL FRAME

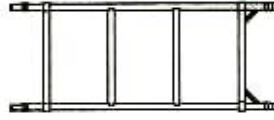

2.0M S/WIDTH FRAME

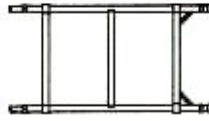

1.5M S/WIDTH FRAME

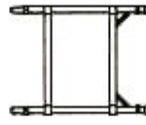

1.0M S/WIDTH FRAME



S/WIDTH GIR/RAIL FRAME

OTHER TOWER COMPONENTS



STANDARD PLATFORMS
1.3M, 2.0M, 2.5M, & 3.0M



HATCHDOOR PLATFORMS
1.3M, 2.0M, 2.5M, & 3.0M



CASTOR



ADJUSTABLE LEG



TOEBOARDS
SINGLE WIDTH & DOUBLE WIDTH
1.3M, 2.0M, 2.5M, & 3.0M

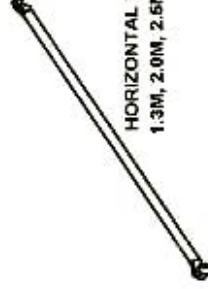

HORIZONTAL BRACES
1.3M, 2.0M, 2.5M, & 3.0M



DIAGONAL BRACES
TO SUIT
1.3M, 2.0M, 2.5M, & 3.0M

STABILISERS / OUTRIGGERS



SMALL

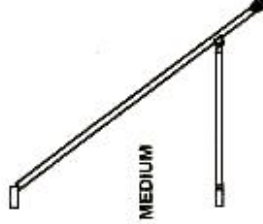

MEDIUM

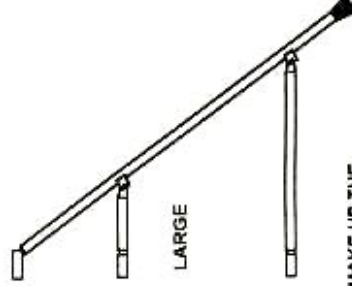

LARGE

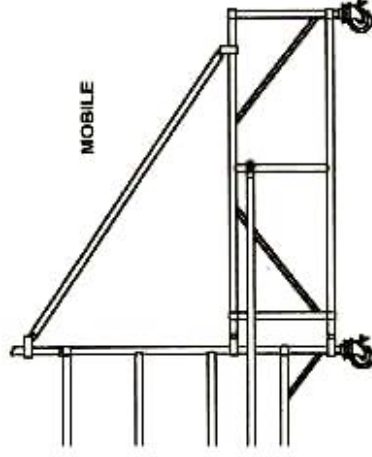

MOBILE

THE ABOVE ILLUSTRATES THE BASIC COMPONENTS WHICH MAKE UP THE STANDARD TOWERS. OTHER SPECIALISED ITEMS SUCH AS HIGH CLEARANCE PLATFORMS, WALK THROUGH FRAMES ETC CAN BE SUPPLIED ON REQUEST.

SAFETY LEGISLATION AND HD1004

THE STAIRSPAN TOWER SYSTEM COMPLIES FULLY WITH ALL CURRENT UK SAFETY LEGISLATION AND CAN BE EASILY UP-GRADED TO THE LATEST EUROPEAN STANDARD HD1004 WHICH STIPULATES THAT CERTAIN CRITERIA HAVE TO BE MET REGARDING REST PLATFORMS, LOADINGS AND OTHER TECHNICAL SPECIFICATIONS.

THE MANUFACTURER RESERVES THE RIGHT TO ALTER SPECIFICATIONS WITHOUT PRIOR NOTICE

INTERLINK

INTERLINK ALLOY SYSTEMS LIMITED
Southend Farm, Southend Lane
Waltham Abbey, Essex EN9 3SE
☎ 01992 716579/716509